

E6-L 蓝牙音箱
Bluetooth Speaker

使用说明书
USER MANUAL

Table of Contents

01 - 08 English

09 - 16 简体中文

17 产品售后服务条例

产品保修卡

01 Warnings

English



- ◆ To ensure proper use and trouble-free operation, please carefully read this user manual first.
- ◆ For the first use, a full charge is recommended.
- ◆ Please use and store the product at room temperature.
- ◆ Do not throw and drop the product to avoid damages.
- ◆ Do not expose the product to fire, high temperature, direct sunlight, etc.
- ◆ Do not use organic solvents or other chemicals to clean the product.
- ◆ Do not allow small particles to get into the product.
- ◆ Please keep volumes of the speaker moderate to avoid temporary or permanent hearing impairment.
- ◆ Do not disassemble the product, or make any modifications to the structure or any parts of it.
- ◆ Keep the product out of children's reach.
- ◆ If the battery is not properly replaced, there will be an explosion accident, which can only be replaced with the same type of battery.
- ◆ Batteries (battery packs) can not be exposed to such conditions as sunshine, fire or similar overheating conditions.

02 Packing contents

English

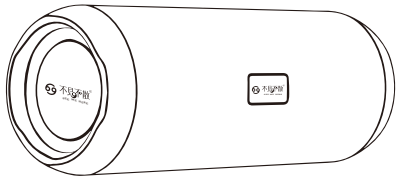

E6-L 1pc

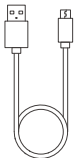

USB-C charging/data cable 1pc



3.5mm audio cable 1pc

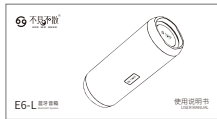

User manual 1pc



Strap 1pc

03 Instructions of buttons

English

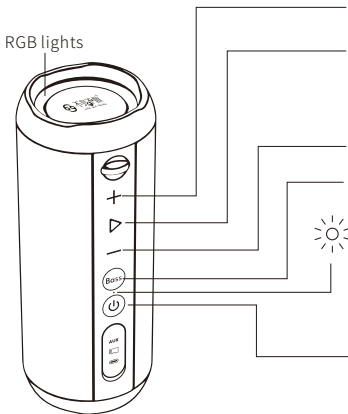

Press: turn up **press and hold:** skip to the next track

Under playback: press to play/pause

When a call comes in: press to receive, end; press and hold to reject.

Disconnection: press and hold 2s, disconnect the Bluetooth.

RGB display: press two times to shift different display modes.

Press: turn down **press and hold:** skip to the previous track.

Press to switch standard and bass enhancing modes



LED indicator

Power on: Blue LED flickering, it stays once Bluetooth connected.

MAX/MIN vol.: blue LED quick flashing.

Power button: press and hold 2s to turn on or turn off / press two times to check battery capacity.

Reset: press and hold 8s to reset.

Modes shifts: press to shift different modes(Bluetooth-->Micro SD -->AUX IN) need insert Micro SD card +3.5mm audio cable

04 Instructions of ports

English

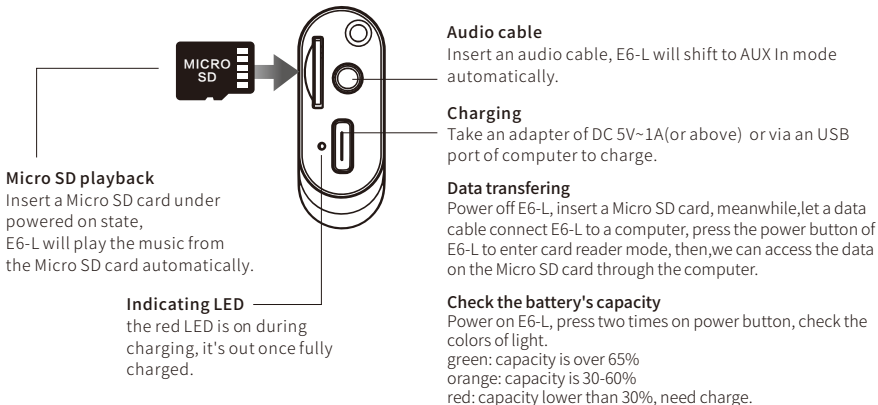

05 Bluetooth connection

English

1、Power on E6-L

Press and hold the power button for 2s, its LED flickers, it means ready to pair a Bluetooth device.

2、Connect to a Bluetooth device

Go to Bluetooth page of the device, search and connect the pairing name "E6-L", The LED will stay once connected.

This BT device and E6-L will reconnect each other in the future use.

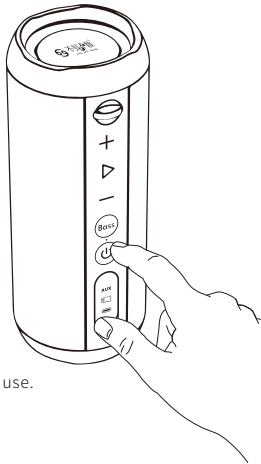

06 TWS(True Wireless Stereo) function

English

it means we can play two speakers at the same time.



main speaker



following speaker

1. How to set the TWS

Prepare 2pcs E6-L, turn on them, and both are under Bluetooth available state;

Take either of E6-L, press "+ -" at the same time, the TWS is done with a prompt sound.

2. Let the TWS set connect to a Bluetooth device

Go to Bluetooth page of the device, search and connect the pairing name " E6-L",
The LED will stay once connected.

3. How to disconnect the TWS

Take either of E6-L, just press "+ -" at the same time.

Tips

01, the one you took to press "+-" to set TWS, is the main speaker & left channel and the other one is the following speaker & right channel.

02, a TWS set only support 2pcs E6-L.

03, TWS set will keep the consistency of main/following speakers, both will reconnect each other automatically when powered on.

04, When the TWS set is done, the LED of following_E6-L keep staying; and the LED of main_E6-L will indicate the playback/pause/connecting via flickering/stay.

05, Press the buttons on either E6-L has same operations.

07 Specifications

English

Basic parameters	
Speaker Type	Bluetooth speaker
Storage Type	Support Micro SD card within 32GB capacity
Power supply	DC 5V-1A power, the charging time is around 4.5 hours
Technical parameters	
Drivers	2pcs 50mm positive drivers+2pcs 60mm bass enhancing radiators.
Frequency response	60-20KHZ
Bluetooth version	Bluetooth 5.3
USB	USB2.0, compatible with USB1.1
Formats on Micro SD card	
Bit rates	MP3: 8Kbps-320Kbps WMA: 32Kbps-384Kbps MAV: 32Kbps-1414Kbps

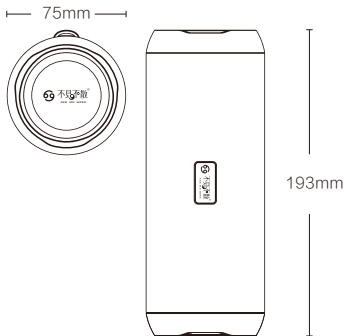

Product size: 193x75x75mm

Product weight: 508g(built-in battery)

08 注意事项

简体中文

- ◆请阅读本说明。
- ◆请遵循本说明。
- ◆请在常温环境中存放和使用本产品。
- ◆请勿在近热源处使用本产品，如散热器、热风调节器、炉灶或其他产生热量的仪器（包括放大器）。
- ◆请勿堵塞音箱的开口处，勿将物体塞入音箱的通风口或槽隙中。
- ◆请勿丢掷，避免因跌落造成本产品损坏。
- ◆请使用音箱额定电压的电源充电器充电。
- ◆如果连接线与您的设备不匹配，请与销售商联系。
- ◆请将音箱调至合适音量，避免对您的听力造成损害。
- ◆无论设备因何原因损坏，都必须及时请专业维修人员修理，擅自拆卸将使保修失效。
- ◆如果电池更换不当会有爆炸危险，只能用同样类型或等效类型的电池来更换。
- ◆禁止拆解、撞击、挤压或投入火中；若出现严重鼓胀，请勿继续使用；请勿置于高温环境中，电池浸水后禁止使用。
- ◆电池（电池包或组合电池）不得暴露在诸如日照、火烤或类似过热环境中。
- ◆消费者若使用电源适配器充电，则应购买配套使用获得CCC认证并满足标准要求的电源适配器。

09 包装清单

简体中文

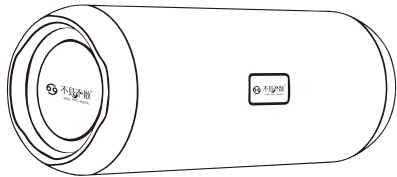

音箱主机 1台

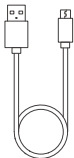

USB电源线/数据线 1条



3.5mm音频线 1条

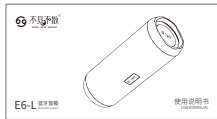

使用指南 1份



挂绳 1条

10 按键功能指示

简体中文

RGB灯光

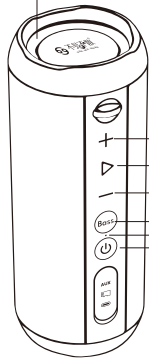

短按：音量增大 长按：下一曲

播放音乐时：短按 播放 / 暂停

通话接听键：短按接听、挂断，长按拒接来电

蓝牙断开：长按2秒断开与当前设备连接

RGB灯光调节：双击PLAY可以切换RGB灯模式

短按：音量减小 长按：上一曲

BASS键：短按在普通音效 / 低音增强之间切换



LED指示灯

开机：蓝灯闪烁，等待蓝牙配对，连接成功蓝灯常亮

最大/最小音量：蓝灯快闪提示

电源键：长按2秒开关机 / 双击查看电量

系统复位：长按电源键8秒复位

模式切换：短按模式切换

蓝牙模式 → Micro Sd卡音乐模式 → AUX外接音源模式
(需插入Micro SD卡 + 连接音频线) 切换

11 接口功能指示

简体中文

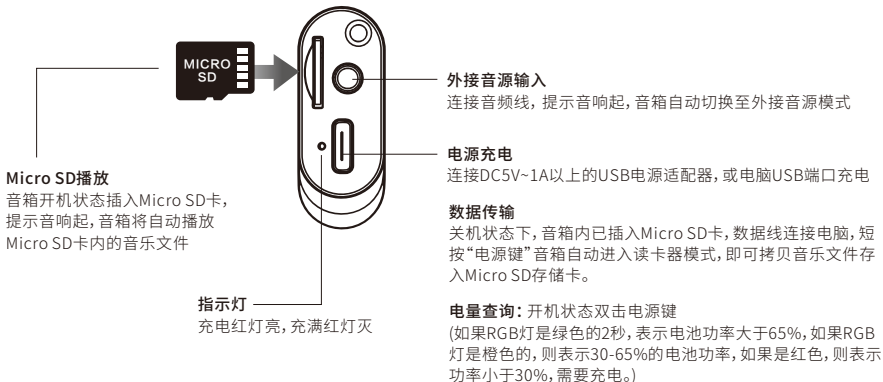

12 蓝牙音频连接

简体中文

1、音箱开机

长按电源键2秒开机，开机提示音响起后，接着提示音响起蓝灯闪烁，等待蓝牙配对。

2、连接到移动设备

开启移动设备蓝牙选项，在蓝牙设备列表中找到E6-L，连接成功您将听到提示音，同时LED指示蓝灯常亮。

后续使用中，只要保持移动设备的蓝牙开启，即可自动连接。

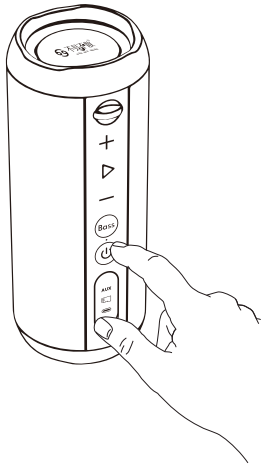



主音箱



从音箱

1、TWS连接操作

两台处于开机状态并且没有连接蓝牙的音箱，同时短按其中一台“+ -”键，听到提示音后，音箱进入TWS串联模式，稍后再次听到提示音，两个音箱无线串联成功。

2、将串联音箱连接到移动设备播放

开启移动设备蓝牙选项，在蓝牙设备列表中找到 E6-L，连接成功您将听到提示音，同时LED指示蓝灯常亮。

3、TWS断开操作

已串联成功的两个音箱，同时短按其中一个音箱的“+ -”按键，可断开TWS连接。

其它说明：

01、首次两台音箱进行TWS串联，短按其中一台“+ -”键进入TWS串联的音箱为主音箱左声道，另一台为从音箱右声道。

02、TWS无线串联，仅支持2个音箱设备无线串联。

03、TWS串联过后的两台音箱，会记忆之前的主从关系，两台音箱下次开机后会自动TWS串联。

04、TWS串联后，从音箱LED指示灯是长亮，由主音箱指示灯显示播放、暂停、和手机蓝牙连接等状态。

05、无线串联成功后，操作任意一音箱功能按键，另一音箱同步相应操作。

14 技术参数

简体中文

基本参数	
音箱类型	蓝牙音箱
存储类型	支持容量不大于32G Micro SD卡
电源供应	DC5V-1A的USB电源 充电约4.5小时左右
技术参数	
扬声器单元	2只 方形50mm 喇叭+ 2只65mm低频辐射器
频率响应	60-20KHZ
无线连接	Bluetooth 5.3
USB规格	USB2.0、兼容USB1.1
播放功能	
文件格式	MP3:8Kbps-320Kbps WMA:32Kbps-384Kbps WAV:32Kbps-1414Kbps

产品规格:193×75×75mm

产品净重:508g(含内置锂电池)

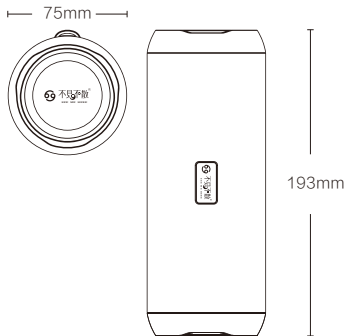



自助售后服务



不见不散公众号

生产企业:深圳市不见不散电子有限公司

地 址: 深圳市宝安区航空路32号-不见不散视听创新园

电 话: 0755-61181399 网 址: www.hb2099.com